



# Adjustment instructions ESA

Subject to technical changes

Framo Morat GmbH & Co. KG  
Höchst 7 • D-79871 Eisenbach

Tel.: +49 (0) 7657 / 88-0  
Fax: +49 (0) 7657 / 88-333

[www.framo-morat.com](http://www.framo-morat.com)  
[info@framomorat.com](mailto:info@framomorat.com)

## Adjustment instructions

### Attention

Please follow these instructions carefully!  
 Connection and adjustment has to be carried by a trained electrician!

Make sure that your working area is free of any voltage and that the power cannot be turned on accidentally while working on the opened ESA. The Compacta should not be connected to a power supply before you have ensured that the earth connection is provided. Check that the motor voltage is correct for the given supply (Refer to name plate). Connect the ESA according to the connection diagram!

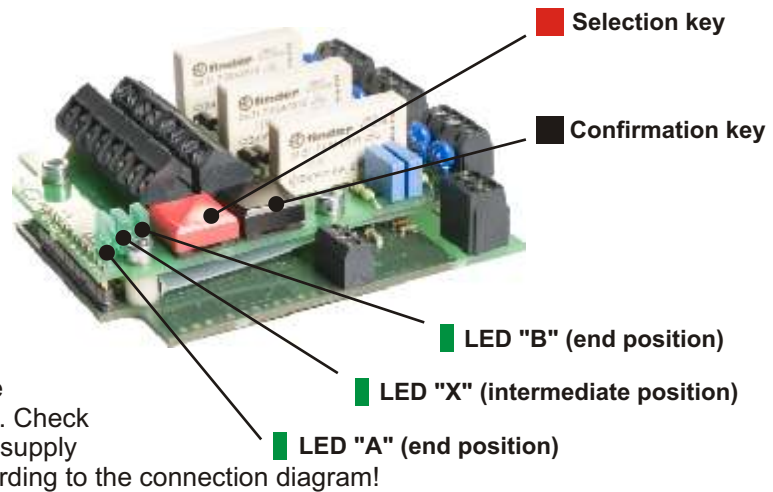

### General

The drive is delivered without preassigned end positions unless this was ordered. All LEDs flash fast.

Once the first end position is defined you have to consider the maximum limit switch range (it depends on the number of revolutions of the hollow shaft) in the output tables.

### Definition of the rotating direction and the end positions

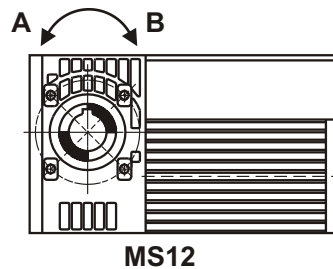
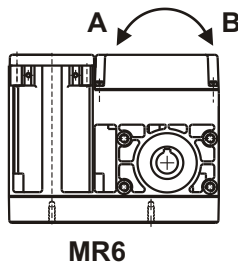

LED "A" defines the end position "A"

LED "B" defines the end position "B"

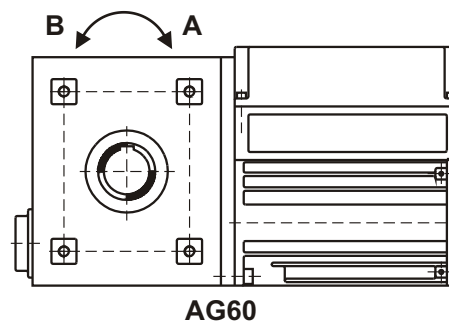
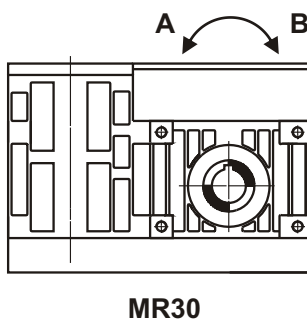

### Basics for programming:

- Every end or intermediate position has to be approached individually.
- The program mode has to be activated for every single position.
- After entering the program mode the "Selection key" ist used to define wether the actual position is one of the end positions ("A" or "B"), or an intermediate position ("X").
- By pressing the "Confirmation key" the position is saved.

Subject to technical changes

### Consideration of backlash

While programming the end- and intermediate positions the backlash has to be considered. The amount of backlash depends on gear ratio, speed and load. Detailed information can be taken from the diagram in the chapter 'Technical description'.

Backlash takes effect into the direction the drive is moving (fig. 1). Therefore the switching points have to be programmed in the same direction the drive moves while approaching the position in operation mode (fig. 2 and 3). This allows a high stopping accuracy.

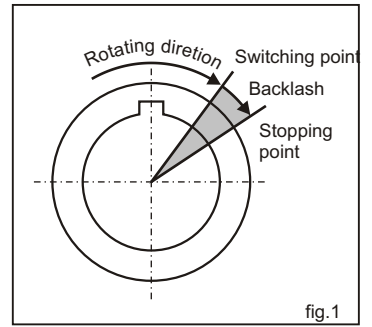

### Right

Rotating direction **is** equivalent to the direction during program mode

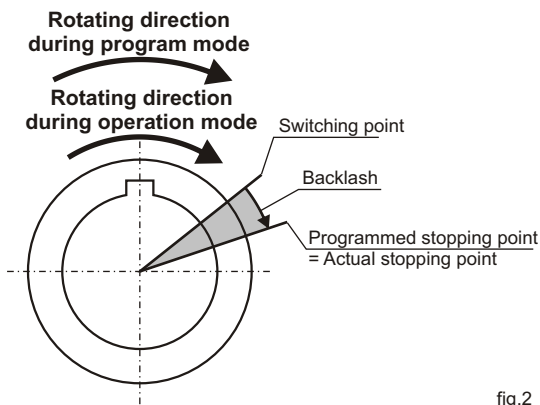

### Wrong

Rotating direction **is not** equivalent to the direction during program mode

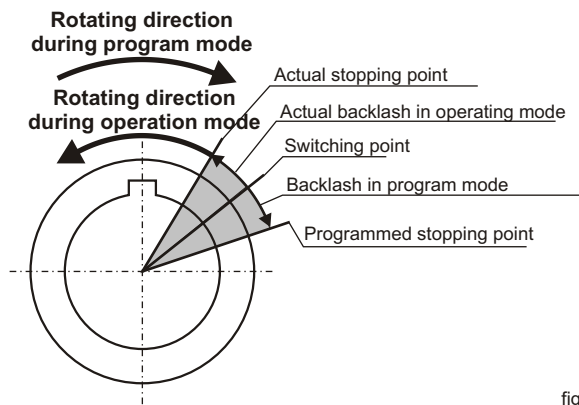

### Initial operation

Start up is easy and quick.

### Delivery status

#### Option 1: ESA preset by Framo

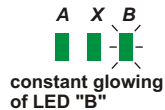















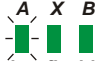





If the programming is done by Framo, the drive stands on 'end position A'. LED "B" is glowing constantly.

After connecting the Compacta according to the wiring diagram start running the unit.

#### Option 2: ESA is not preset

Action	Feedback	Explanation
	<p>fast flashing of all LEDs</p>	All LEDs are flashing fast → The ESA is not programmed
1x short push	<p>constant glowing of LED "A" and LED "B"</p>	Press the confirmation key → LED "A" and LED "B" are glowing constantly. This signals that no end position is reached or programmed.

Now you can program the ESA as follows:

	Action	Feedback	Explanation
<b>End position "A"</b>		 constant glowing of LED "A" and LED "B"	Drive to end position "A" manually
	 until LED "B" starts to flash (approx. 6 Sec.)	 slow flashing of LED "B"	Press confirmation key and hold it. In addition then press the selection key. Hold both keys for approx. 6 sec. → Program mode is now activated → End position "B" is pre-selected
	 1x short push	 slow flashing of LED "A"	By pressing the selection key once the slow flashing shifts to LED "A" (end position) → End position "A" is selected for the present position
	 1x short push	 slow flashing of all LEDs	Press confirmation key → The programming was successful when all LEDs flash slowly for a period of 3-4 seconds → End position "A" ist now defined
		 constant glowing of LED "B"	LED "B" is glowing constantly, program mode is finished
		 constant glowing of LED "A" and LED "B"	Drive to end position "B" → LED "A" and LED "B" are glowing constantly
<b>End position "B"</b>		 constant glowing of LED "A" and LED "B"	Drive to end position "B" manually
	 until LED "B" starts to flash (approx. 6 Sec.)	 slow flashing of LED "B"	Press confirmation key and hold it. In addition then press the selection key. Hold both keys for approx. 6 sec. → Program mode is activated → End position "B" is pre-selected
	 1x short push	 slow flashing of all LEDs	Press confirmation key → The programming was successful when all LEDs flash slowly for a period of 3-4 seconds → End position "B" ist now defined
		 constant glowing of LED "A"	LED "A" is glowing constantly, program mode is finished
		 constant glowing of LED "A" and LED "B"	Drive to first intermediate position "X" → LED "A" and LED "B" are glowing constantly

Subject to technical changes

## Intermediate positions

Action	Feedback	Explanation
		Drive to intermediate position "X" manually
		Press confirmation key and hold it. In addition then press the selection key. Hold both keys for approx. 6 sec. → Program mode is activated → End position "B" is pre-selected
		By pressing the selection key twice the slow flashing changes to intermediate position (LED) "X" → Intermediate position "X" is selected for the present position
		Press confirmation key → The programming was successful when all LEDs flash slowly for a period of 3-4 seconds → Intermediate position "X" is now defined
		LED "A" and LED "B" are glowing constantly, Program mode has ended

In this way up to 10 intermediate positions "X" can be programmed.

## Changing the defined positions

Corrections of the switching positions can be done easily.

### Complete reset (regain delivery status)

Action	Feedback	Explanation
		Press selection key permanently
		After approx. 5 seconds the rotational flashing of the LED's starts, reset mode has started (keep selection key pressed)
		<b>Important:</b> when the rotational flashing has started, press the confirmation key within 3 seconds while still pressing the selection key → all positions are now deleted
		Afterwards LED "A" and "B" are glowing constantly

**All positions are deleted!**







Subject to technical changes

## Important!

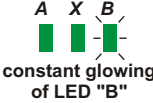
If one end position is deleted, all intermediate positions lose their reference and do not switch until both end positions are set again.

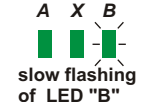

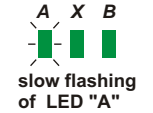

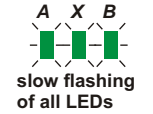
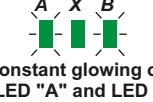
### Deleting end position "A"

Drive to end position "A" and activate the program mode.

Action	Feedback	Explanation
	 constant glowing of LED "B"	Drive to end position "A"
 until LED "B" starts to flash (approx. 6 Sec.)	 slow flashing of LED "B"	Press confirmation key and hold it. In addition then press the selection key. Hold both keys for approx. 6 sec. → Program mode is activated. → End position "B" is pre-selected for reset
 1x short push	 slow flashing of LED "A"	By pressing the selection key once the slow flashing shifts to LED "A" (end position) → End position "A" is selected for reset
 press + hold	 slow flashing of all LEDs	Press and hold the confirmation key until all LED's flash slowly → After approx. 3-4 seconds LED "A" and LED "B" are glowing constantly → End position "A" is now deleted.
	 constant glowing of LED "A" and LED "B"	LED "A" and LED "B" are glowing constantly → Program mode is finished

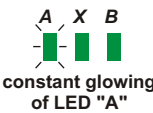
### Deleting end position "B"

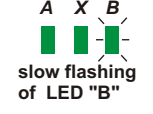

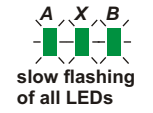
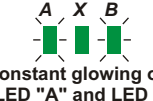







Drive to end position "B" and activate the program mode.

Action	Feedback	Explanation
	 constant glowing of LED "A"	Drive to end position "B"
 until LED "B" starts to flash (approx. 6 Sec.)	 slow flashing of LED "B"	Press confirmation key and hold it. In addition then press the selection key. Hold both keys for approx. 6 sec. → Program mode is activated. → End position "B" is pre-selected for reset
 press + hold	 slow flashing of all LEDs	Press and hold the confirmation key until all LED's flash slowly → After approx. 3-4 seconds LED "A" and LED "B" are glowing constantly → End position "A" is now deleted.
	 constant glowing of LED "A" and LED "B"	LED "A" and LED "B" are glowing constantly → Program mode is finished

Subject to technical changes

## Deleting an intermediate position

Drive to the intermediate position and activate the program mode.

Action	Feedback	Explanation
	 constant glowing of LED "A" and LED "B"	Drive to the intermediate position you want to delete
  until LED "B" starts to flash (approx. 6 Sec.)	 slow flashing of LED "B"	Press confirmation key and hold it. In addition then press the selection key. Hold both keys for approx. 6 sec. → Program mode is activated. → End position "B" is pre-selected for reset
 2x short push	 slow flashing of LED "X"	By pressing the selection key twice the slow flashing shifts to LED "X" (intermediate position) → Intermediate position "X" is selected for reset
 press + hold	 slow flashing of all LEDs	Press and hold the confirmation key until all LED's flash slowly → After approx. 3-4 seconds LED "A" and LED "B" are glowing constantly → Intermediate position "X" is now deleted.
	 constant glowing of LED "A" and LED "B"	LED "A" and LED "B" are glowing constantly → Program mode is finished

